

Temperature transmitters for RTD and thermocouples

iTEMP TMT127 / 187 and TMT128 / 188



TMT187 / 188

TMT127 / 128

- High accuracy (in total ambient temperature range)
- Fault indication on sensor short or open circuit to NAMUR NE 43
- Galvanic isolation

i Specs at a glance:

- **Approval:**
ATEX II (1) G EEx ia
- **Accuracy:**
<0.08 % (Pt100)
- **Measuring range:**
Fixed, selectable
- **RTD sensors:**
3 or 4-wire

Application This range of temperature transmitters are available as either head transmitters (TMT187/188) or as rail mounted devices (TMT127/128). The TMT187/188 head transmitters can be installed in the form B sensor head and have a fixed measurement range as well as a 4 to 20 mA analog output.

Input:

TMT127/187 resistance thermometer (RTD) or
TMT128/188 thermoelements (TC)

Function The TMT127/187 RTD temperature transmitter is a two-wire transmitter with an analog output and a three- or four-wire resistance thermometer input.

The TMT128/188 TC temperature transmitter is a two-wire transmitter with an analog output and thermocouple input.



Complete product information:

www.e-direct.endress.com/tmt1xx

Technical data TMT187 / TMT188

Input	
TMT187 (RTD)	Pt100
TMT188 (TC)	Type J, K, N, R, S, T
Output	
Output signal	4 to 20 mA transmission is linear to temperature and resistance
Maximum load	$(V_{\text{power supply}} - 8 \text{ V}) / 0.025 \text{ A}$
Input current required	$\leq 3.5 \text{ mA}$
Current limit	$\leq 25 \text{ mA}$
Switch on delay	4 s (during power up $I_a = 3.8 \text{ mA}$)
Response time	1 s
Signal on alarm	
Underranging	Linear drop to 3.8 mA
Overranging	Linear rise to 20.5 mA
Sensor breakage/ Sensor short circuit	$\geq 21.0 \text{ mA}$
Electrical connection	
Power supply	$U_b = 8$ to 35 V, reverse polarity protected Ex $U_b = 8$ to 30 V
Galvanic isolation	$U = 2 \text{ kV AC}$
Allowable ripple	$U_{ss} \leq 5 \text{ V}$ at $U_b \geq 13 \text{ V}$, $f_{\text{max}} = 1 \text{ kHz}$
Reference conditions	Calibration temperature $23 \text{ }^\circ\text{C} \pm 5 \text{ K}$ ($73.4 \text{ }^\circ\text{F} \pm 9 \text{ }^\circ\text{F}$)
Accuracy	
Influence of power supply	$\leq \pm 0.01 \text{ } \%/ \text{V}$ deviation from 24 V
Load influence	$\leq \pm 0.02 \text{ } \%/ 100 \text{ } \Omega$
Temperature drift	Pt100: $T_d = \pm (15 \text{ ppm/K} \times (\text{max. measuring range} + 200) + 50 \text{ ppm/K} \times \text{preset measuring range}) \times \Delta\theta$ TC: $T_d = \pm (50 \text{ ppm/K} \times \text{max. measuring range} + 50 \text{ ppm/K} \times \text{preset measuring range}) \times \Delta\theta$ $\Delta\theta =$ Deviation of ambient temperature from the referent working condition ($+23 \text{ }^\circ\text{C} \pm 5 \text{ K}$ ($73.4 \text{ }^\circ\text{F} \pm 9 \text{ }^\circ\text{F}$))
Pt100	0.2 K or 0.08 %
Thermocouple type	J and K: typ. 0.5 K N: typ. 1.0 K S and R: typ. 2.0 K Influence of the internal reference junction: Pt100 Class B
Operating conditions	
Ambient temperature	-40 to $+85 \text{ }^\circ\text{C}$ (-40 to $185 \text{ }^\circ\text{F}$)
Storage temperature	-40 to $+100 \text{ }^\circ\text{C}$ (-40 to $212 \text{ }^\circ\text{F}$)
Climatic class	According to EN 60 654-1, Class C
Vibration protection	4 g/2 to 150 Hz acc. to IEC 60 068-2-6
EMC	Interference immunity and interference emission according to EN 61 326-1 (IEC 1326) and NAMUR NE 21
Max. ambient temperature	$T_4 = 85 \text{ }^\circ\text{C}$, $T_5 = 70 \text{ }^\circ\text{C}$, $T_6 = 55 \text{ }^\circ\text{C}$ ($T_4 = 185 \text{ }^\circ\text{F}$, $T_5 = 158 \text{ }^\circ\text{F}$, $T_6 = 131 \text{ }^\circ\text{F}$)
Approvals	
Ex approval	ATEX II 1G EEx ia/IIC EEx ia/IIB
Inductivity and capacity	$C_0 \approx 0 \text{ F}$ $C_0 \leq 709 \text{ } \mu\text{F}$ $C_0 \leq 1300 \text{ } \mu\text{F}$ $L_1 \approx 0 \text{ H}$ $L_0 \leq 4.5 \text{ mH}$ $L_0 \leq 100 \text{ mH}$
Max. current	$I_1 = 100 \text{ mA}$ $I_0 = 4.5 \text{ mA}$
Max. voltage	$U_1 = 30 \text{ V}$ $U_0 = 9.6 \text{ V}$
Max. power	$P_1 = 0.75 \text{ W}$ $P_0 = 11 \text{ mW}$

Technical data TMT127 / TMT128

Input	
TMT127 (RTD)	Pt100
TMT128 (TC)	Type J, K, N, R, S, T
Output	
Output signal	4 to 20 mA transmission is linear to temperature and resistance
Max. load	$(V_{\text{power supply}} - 12 \text{ V}) / 0.022 \text{ A}$
Input current required	$\leq 3.5 \text{ mA}$
Current limit	$\leq 23 \text{ mA}$
Switch on delay	4 s (during power up $I_a = 3.8 \text{ mA}$)
Response time	1 s
Signal on alarm	
Underranging	Linear drop to 3.8 mA
Overranging	Linear rise to 20.5 mA
Sensor breakage/ Sensor short circuit	$\geq 21.0 \text{ mA}$
Electrical connection	
Power supply	$U_b = 12$ to 35 V, reverse polarity protected Ex $U_b = 12$ to 30 V
Galvanic isolation	$U = 2 \text{ kV AC}$
Allowable ripple	$U_{ss} \leq 3 \text{ V}$ at $U_b \geq 15 \text{ V}$, $f_{\text{max}} = 1 \text{ kHz}$
Reference conditions	Calibration temperature $25 \text{ }^\circ\text{C} \pm 5 \text{ K}$ ($77 \text{ }^\circ\text{F} \pm 9 \text{ }^\circ\text{F}$)
Accuracy	
Influence of power supply	$\leq \pm 0.01 \text{ } \%/ \text{V}$ deviation from 24 V
Load influence	$\leq \pm 0.02 \text{ } \%/ 100 \text{ } \Omega$
Temperature drift	Pt100: $T_d = \pm (15 \text{ ppm/K} \times (\text{max. measuring range} + 200) + 50 \text{ ppm/K} \times \text{preset measuring range}) \times \Delta\theta$ TC: $T_d = \pm (50 \text{ ppm/K} \times \text{max. measuring range} + 50 \text{ ppm/K} \times \text{preset measuring range}) \times \Delta\theta$ $\Delta\theta =$ Deviation of ambient temperature from the referent working condition ($+23 \text{ }^\circ\text{C} \pm 5 \text{ K}$ ($73.4 \text{ }^\circ\text{F} \pm 9 \text{ }^\circ\text{F}$))
Pt100	0.2 K or 0.08 %
Thermocouple type	J and K: typ. 0.5 K N: typ. 1.0 K, S and R: typ. 2.0 K Influence of the internal reference junction: Pt100 Class B
Operating conditions	
Ambient temperature	-40 to $+85 \text{ }^\circ\text{C}$ (-40 to $185 \text{ }^\circ\text{F}$)
Storage temperature	-40 to $+100 \text{ }^\circ\text{C}$ (-40 to $212 \text{ }^\circ\text{F}$)
Climatic class	according to EN 60 654-1, Class C
Vibration protection	4 g/2 to 150 Hz acc. to IEC 60 068-2-6
EMC	Interference immunity and interference emission according to EN 61 326-1 (IEC 1326) and NAMUR NE 21
Max. ambient temperature	$T_4 = 85 \text{ }^\circ\text{C}$, $T_5 = 70 \text{ }^\circ\text{C}$, $T_6 = 55 \text{ }^\circ\text{C}$ ($T_4 = 185 \text{ }^\circ\text{F}$, $T_5 = 158 \text{ }^\circ\text{F}$, $T_6 = 131 \text{ }^\circ\text{F}$)
Approvals	
Ex approval	ATEX II 1G EEx ia/IIC EEx ia/IIB
Inductivity and capacity	$C_1 \approx 0 \text{ F}$ $C_0 \leq 24 \text{ } \mu\text{F}$ $C_0 \leq 12 \text{ } \mu\text{F}$ $L_1 \approx 0 \text{ H}$ $L_0 \leq 100 \text{ mH}$ $L_0 \leq 8.5 \text{ mH}$
Max. current	$I_1 = 100 \text{ mA}$ $I_0 = 9.6 \text{ mA}$
Max. voltage	$U_1 = 30 \text{ V}$ $U_0 = 4.4 \text{ V}$
Max. power	$P_1 = 0.75 \text{ W}$ $P_0 = 11 \text{ mW}$

Dimensions in mm (inches)

TMT187 / TMT188

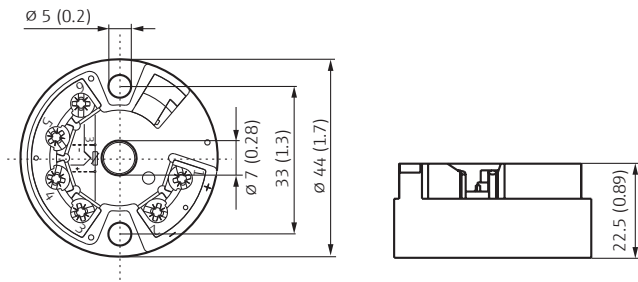

TMT127 / TMT128

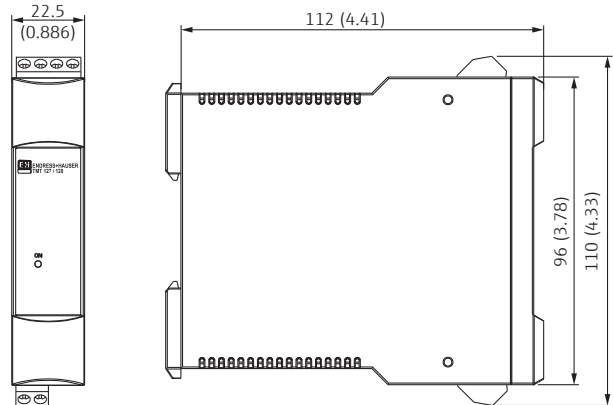

Installation according to operation instructions.

Electrical connection

TMT187 / TMT188

Power supply and current output

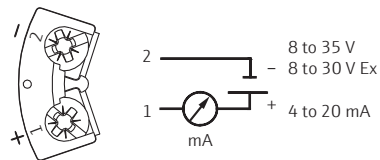

Sensor connection

SETUP socket

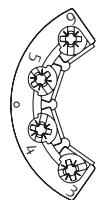

TMT187 three-wire RTD

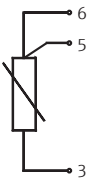

TMT187 four-wire RTD

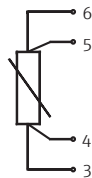

TMT188 TC

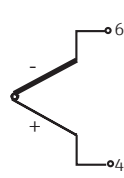

TMT127 / TMT128

Power supply and current output

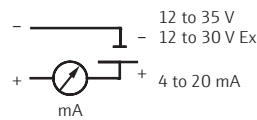

Sensor connection

TC

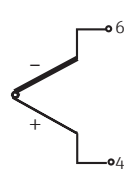

RTD three-wire

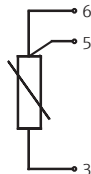

RTD four-wire

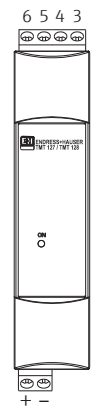
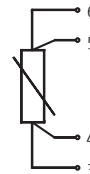

Price table

Measuring range for TMT127/187 (RTD) Pt100

Code	Measuring range	Code	Measuring range
BA	-50to+100°C	FC	0 to +50 °C
CA	-40 to +60 °C	FE	0 to 100 °C
DA	-30 to +60 °C	FG	0 to 150 °C
DB	-30to+150°C	FH	0 to 200 °C
EA	-20 to +20 °C	FI	0 to 250 °C
EB	-20 to +60 °C	FJ	0 to 300 °C
		FK	0 to 400 °C
		FL	0 to 500 °C
		FN	0 to 600 °C

Measuring range for TMT128/188 (TC)

Code	Measuring range	Code	Measuring range	Code	Measuring range
Typ J	0 to 1200 °C	Typ K	0 to 1200 °C	Typ N	0 to 1200 °C
JAB	0 to 150 °C	KAB	0 to 150 °C	NAB	0 to 150 °C
JAK	0 to 200 °C	KAK	0 to 200 °C	NAK	0 to 200 °C
JAC	0 to 250 °C	KAC	0 to 250 °C	NAC	0 to 250 °C
JAL	0 to 300 °C	KAL	0 to 300 °C	NAL	0 to 300 °C
JAD	0 to 400 °C	KAD	0 to 400 °C	NAD	0 to 400 °C
JAЕ	0 to 600 °C	KAЕ	0 to 600 °C	NAЕ	0 to 600 °C
JAF	0 to 900 °C	KAF	0 to 900 °C	NAF	0 to 900 °C
JAG	0 to 1000 °C	KAG	0 to 1000 °C	NAG	0 to 1000 °C
JAH	0 to 1200 °C	KAH	0 to 1200 °C	NAH	0 to 1200 °C
Typ R	0 to 1600 °C	Typ S	0 to 1600 °C	Typ T	-50 to +300 °C
RAE	0 to 600 °C	SAE	0 to 600 °C	TJA	-50 to +200 °C
RAF	0 to 900 °C	SAF	0 to 900 °C	TAA	0 to 100 °C
RAG	0 to 1000 °C	SAG	0 to 1000 °C	TAB	0 to 150 °C
RAH	0 to 1200 °C	SAH	0 to 1200 °C	TAK	0 to 200 °C
RAI	0 to 1400 °C	SAI	0 to 1400 °C	TAC	0 to 250 °C
RAJ	0 to 1600 °C	SAJ	0 to 1600 °C	TAL	0 to 300 °C

iTEMP TMT127/128/187/188				Order no.	Price/pcs. in R		
Design	Product	Approval	Temperature Sensor		1 to 3	4 to 10	11 to 35
Head transmitter	TMT187	Non-Ex	RTD 3-wire	TMT187-A31□A	1440.-	1339.-	1267.-
			RTD 4-wire	TMT187-A41□A	1440.-	1339.-	1267.-
		Ex	RTD 3-wire	TMT187-B31□A	1667.-	1551.-	1467.-
			RTD 4-wire	TMT187-B41□A	1667.-	1551.-	1467.-
	TMT188	Non-Ex	TC	TMT188-A□A	1441.-	1340.-	1268.-
		Ex	TC	TMT188-B□A	1668.-	1551.-	1468.-
Rail mounting transmitter	TMT127 (RTD)	Non-Ex	RTD 3-wire	TMT127-A31□A	1720.-	1600.-	1514.-
			RTD 4-wire	TMT127-A41□A	1720.-	1600.-	1514.-
		Ex	RTD 3-wire	TMT127-B31□A	1948.-	1812.-	1714.-
			RTD 4-wire	TMT127-B41□A	1948.-	1812.-	1714.-
	TMT128 (TC)	Non-Ex	TC	TMT128-A□A	1720.-	1600.-	1514.-
		Ex	TC	TMT128-B□A	1948.-	1812.-	1714.-

* Please add measuring range code for Pt100.

** Please add measuring range code for thermocouple.

Accessory	Order no.	Price/pcs. in R
Protective housing for max. 4 TMT127/128 (182 × 180 × 165 mm)	52010132	1251.83

Prices are applicable for South Africa until 30/06/2020, in Rand (R) per unit, net excluding value added tax (VAT), cost of packing and dispatch. Endress+Hauser retains the right to change or modify pricing at any time. The terms of sales and delivery of Endress+Hauser are applicable. Current prices and delivery times can be verified prior to ordering on www.e-direct.endress.com.

Complete product information: www.e-direct.endress.com/tmt1xx

More products to complete your measuring point ...

